



DB2605 EV Charging HAT for Raspberry Pi

Setup Guide

Rev 1.0.3, July 2024

Please read this manual carefully before use and retain it for future reference.

Contents

1 Overview	2
2 Contents of the Kit	3
3 DB2605 EV Charging HAT	5
4 Setting Up DB2605 EV Charging HAT	7
4.1 Power Source	7
4.2 Power Mode	7
4.3 IEC 61851-1 Source	8
4.4 Control Pilot PWM Signal Selection	8
4.5 Proximity Pilot Power	8
4.6 Boot Configuration for DB2605 Firmware Upgrade	9
5 Charging Configuration Examples	10
5.1 IEC 61851-1 source: Raspberry Pi (CCU)	10
5.2 IEC 61851-1 source: DB2605	11
6 Safety	11
Legal Information	12
Contacting Dropbeats Technology	12
Revision History	12

1 **Overview**

The DB2605 EV Charging HAT (Hardware Attached on Top) for Raspberry Pi is a platform that allows evaluation, software development, and integration of the DB2605, the ISO 15118-2/20 AC charging solution.

For evaluation purposes, the HAT is configured to communicate over the UART interface between the DB2605 and a Raspberry Pi (CCU, Charge Control Unit). The user can establish a charging session by connecting an EV (Electric Vehicle) over the pilot wire or by connecting to an EVCC (Electric Vehicle Communication Controller) that complies with HPGP and ISO 15118.

The HAT also provides several additional product design options to facilitate the development of the intended new product. It can be powered from either a USB type C supply or from the Raspberry Pi interface. In addition, the board has several configuration jumpers, push buttons, and LEDs to further customize the DB2605 per system requirements.

In summary, a wide range of applications is supported by the versatile and flexible configuration of the DB2605 EV Charging HAT.







Features

- DB2605, adding core ISO 15118-2/20 functionalities to AC chargers
- Raspberry Pi 4B/5 HAT
- Raspberry Pi side C code charger simulator
- Single PCB design includes constant-power and low-power option
- Software communication via UART

2 Contents of the Kit

Hardware components

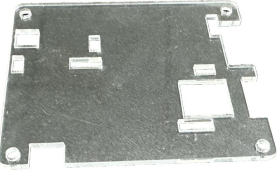
Note – Illustrations are for reference only. Actual product may vary.

Product Item	DB2605 EV Charging Raspberry Pi Kit DB2605 EV Charging HAT		
	DB2605 EV Charging HAT for Raspberry Pi	1	1
	Charging Connector (PP/PE/CP)	1	1
	Jumpers, various colors	8	8
	Attachment standoffs and screws	4	4
	Protective acrylic shield	1	1
	32GB SD Card with Rpi OS and preinstalled tools	1	1
	Raspberry Pi 4B (Also available from the Raspberry Pi web site. https://www.raspberrypi.com/products/raspberry-pi-4-model-b/)		1

Support Material

- Hardware Design
 - Reference Design (IEC 61851-1 Source CCU) Schematic
 - Reference Design (IEC 61851-1 Source CCU) BOM
 - DB2605 3D model (stp file)
 - Recommended PLC Coupling Transformer(2038) Datasheet

- Software
 - DB2605 Firmware
[*DB2605_EV_Charging_FW_GEN_F00_V1.0.x.bin*](#)
 - DB2605 Firmware upgrade tool
[*DB2605_Image_Upgrade_Tool_Rasp_V1.0.x*](#)
 - Charge Control Unit Simulator on Raspberry Pi
[*DB2605_CCU_Simulator_Rasp_V1.0.x*](#)

- Documentation
 - DB2605 EV Charging Controller Brief
 - DB2605 EV Charging Controller Datasheet
 - DB2605 EV Charging HAT Setup Guide (this document)
 - DB2605 EV Charging HAT Firmware Upgrade Guide
 - DB2605 EV Charging Evaluation Kit Quick Start Guide
 - DB2605 EV Charging Evaluation Kit CCU Simulator Guide

- Documentation - NDA Covered
 - DB2605 EV Charging Controller Communication Protocol
 - DB2605 EV Charging Controller Communication Matrix IEC61851-1 Source CCU
 - DB2605 EV Charging Controller Communication Matrix IEC61851-1 Source SECC
 - DB2605 EV Charging Controller Firmware Upgrade Programming Guide



3 DB2605 EV Charging HAT

Figure 1 depicts the main sections of the DB2605 EV Charging HAT.

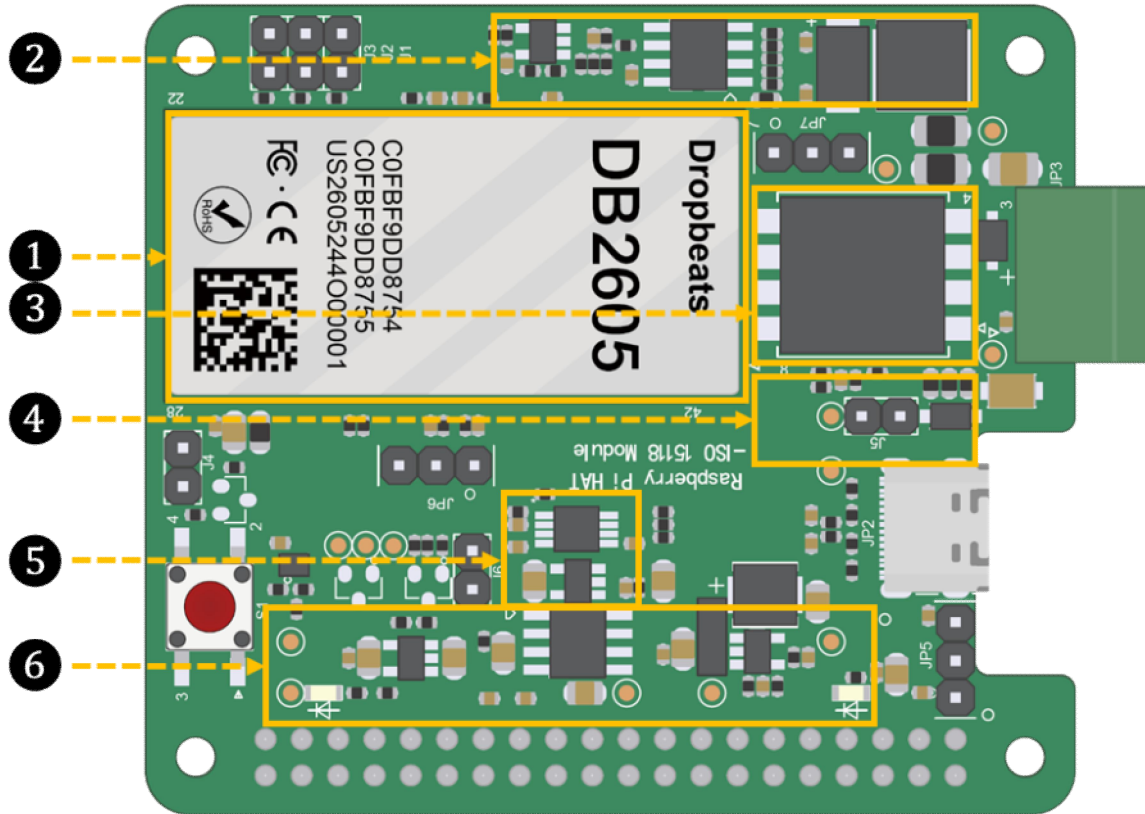

Figure 1 – DB2605 EV Charging HAT Main Sections

Item	Description
1	DB2605 Module
2	Control Pilot PWM generation and measurement
3	Power line signal coupling transformer
4	Proximity pilot circuit and measurement
5	Pilot ADC for Raspberry Pi
6	Internal power: +12V, -12V, 3.3V

Figure 2 depicts the DB2605 EV Charging HAT's connectors, interfaces, jumpers, pushbuttons, and LEDs.

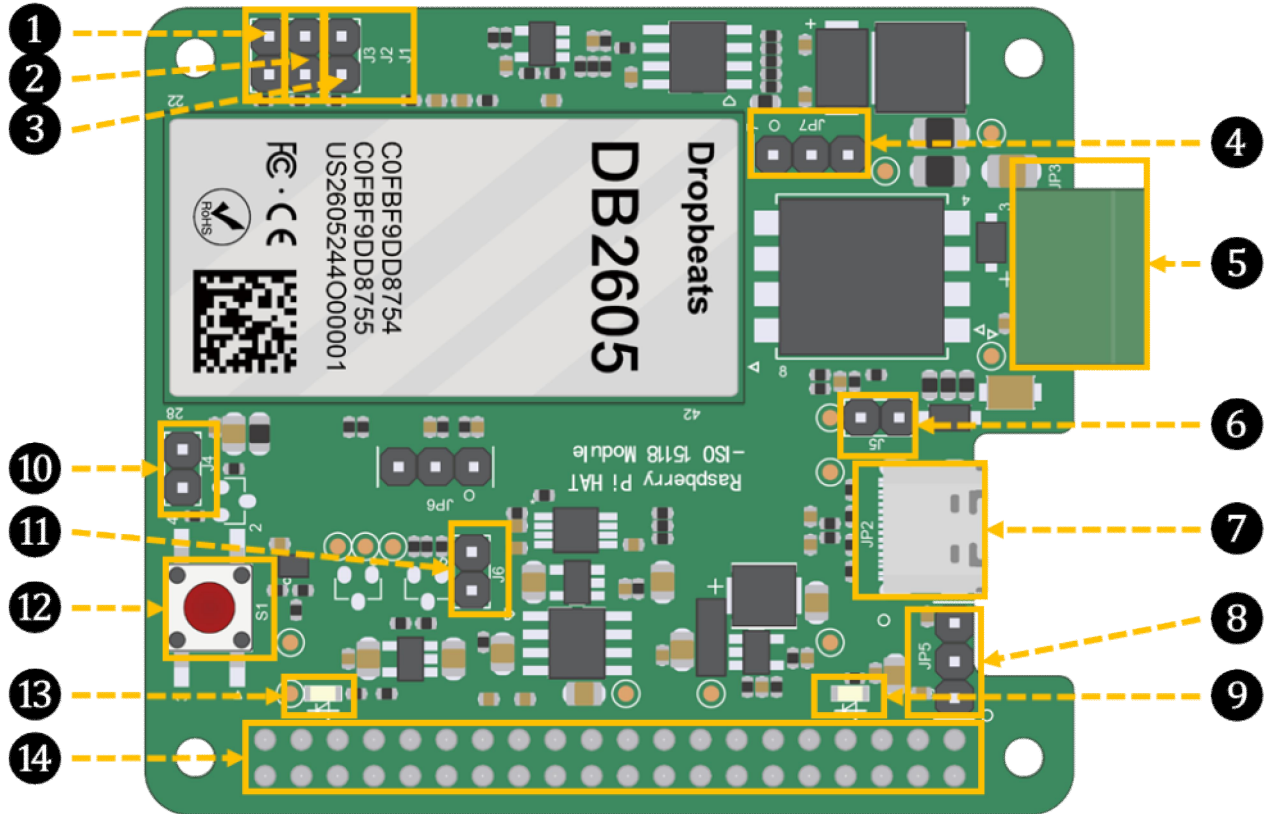

Figure 2 – DB2605 EV Charging HAT Connectors, Interfaces, and Jumpers

Item	Reference	Description
1	J3	Reserved
2	J2	IEC 61851-1 source selection
3	J1	Reserved
4	JP7	Control pilot PWM signal selection
5	JP3	Connector for pilot wire (PP/PE/CP)
6	J5	Proximity pilot power enable/disable
7	JP2	USB type C connector for power supply
8	JP5	Power source selection
9	D4	5V power LED
10	J4	Boot configuration, for DB2605 firmware upgrade
11	J6	Power mode
12	S1	Reset push button
13	D12	3V3 power LED
14	JP1	Raspberry Pi interface

4 Setting Up DB2605 EV Charging HAT

Before booting the DB2605 EV Charging HAT, check that the jumpers are set to the correct positions as explained below.

Note – In the figures below, the orange rectangle indicates a jumper installed between the points shown.

4.1 Power Source

Set with jumper at JP5, Figure 2, item 8

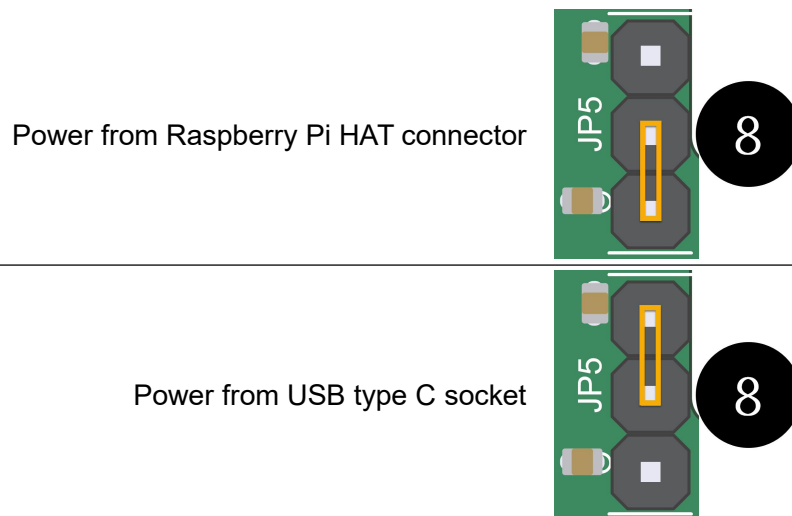

4.2 Power Mode

Set with jumper at J6, Figure 2, item 11

There are two power modes: constant power and low power. The default is low-power mode.

Low-power mode (**Recommended**)
 Internal 3.3V is powered off; DB2605 is powered off. When an EV connects, 3.3V power is awakened automatically, and the DB2605 then boots.

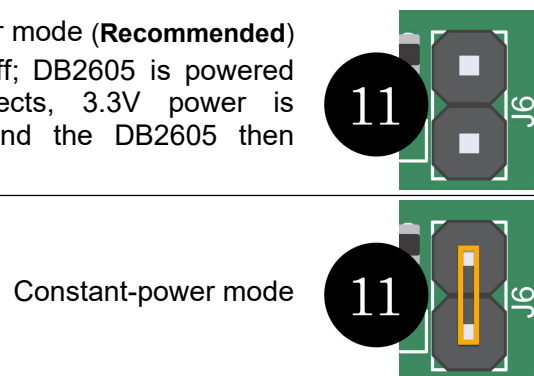

4.3 IEC 61851-1 Source

Control pilot signal could be generated and measured by DB2605 or Raspberry Pi (CCU). See also section 4.4.

Set with jumper at J2, Figure 2, item 2

IEC 61851-1 source is DB2605

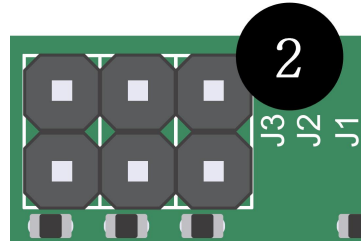

IEC 61851-1 source is Raspberry Pi(CCU)

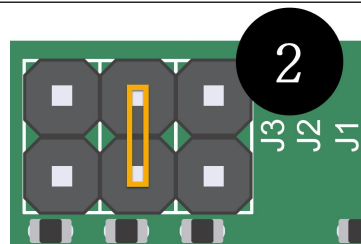

4.4 Control Pilot PWM Signal Selection

Set with jumper at JP7, Figure 2, item 4

DB2605's PWM signal is selected to CP wire



Raspberry Pi's PWM signal is selected to CP wire

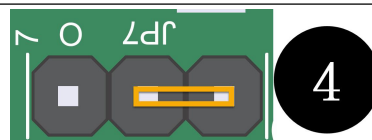

4.5 Proximity Pilot Power

Set with jumper at J5, Figure 2, item 6

Install this jumper only for a European charging station with Charge Mode 3.

Proximity Pilot Power is OFF

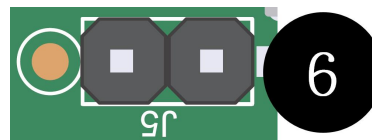

Proximity Pilot Power is ON

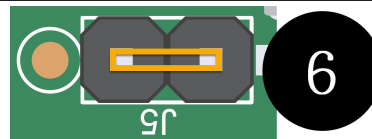

4.6 Boot Configuration for DB2605 Firmware Upgrade

Set with jumper at J4, Figure 2, item 10

DB2605 boots from flash (default)

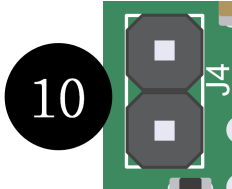

DB2605 boots from external UART0 interface
for firmware upgrade

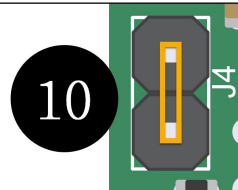

To upgrade firmware, install jumper at J4, then push Reset button (Figure 2, S1, item 12).

5 Charging Configuration Examples

5.1 IEC 61851-1 source: Raspberry Pi (CCU)

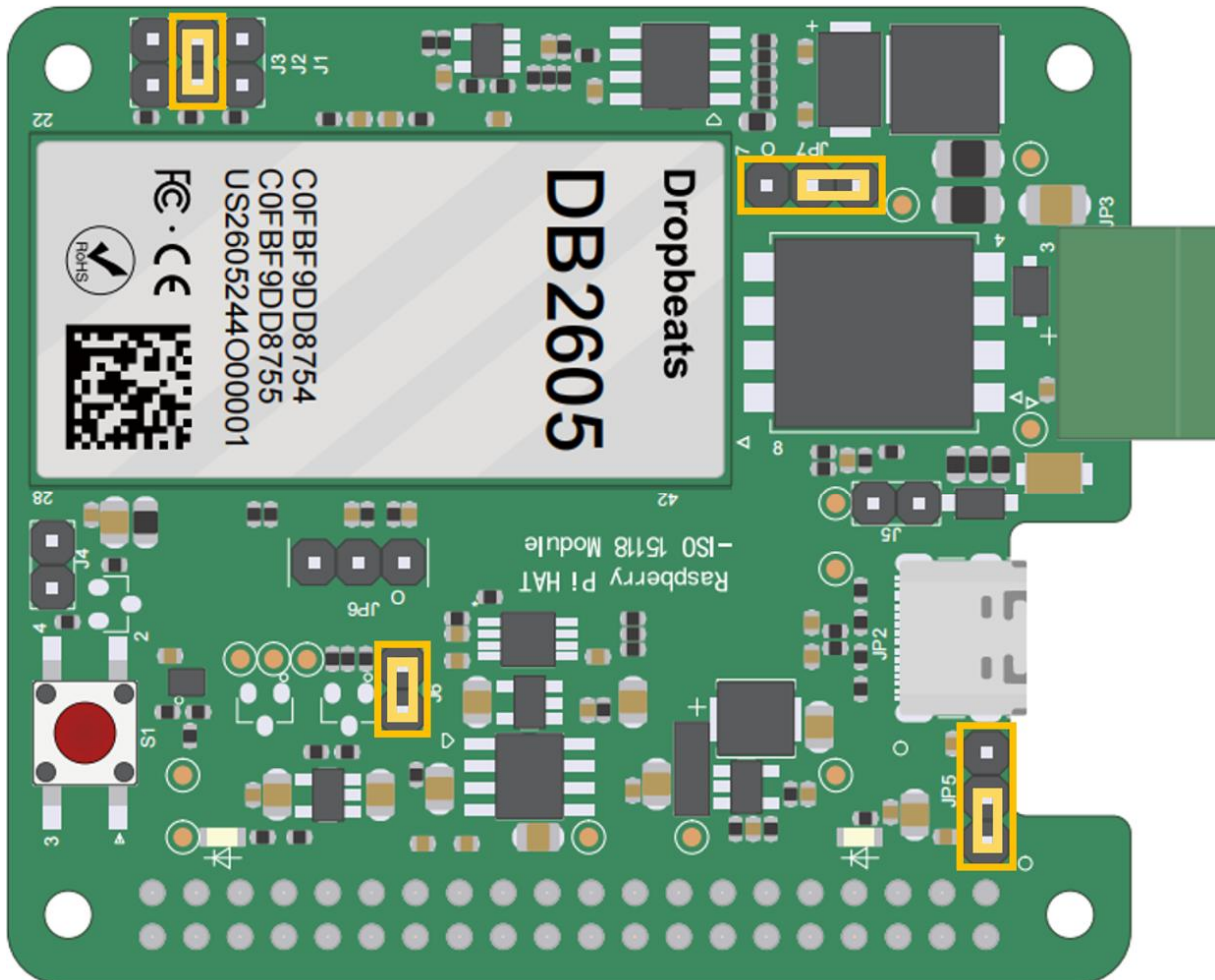

Figure 3 – IEC 61851-1 source: Raspberry Pi (CCU)

In this example,

- Power is provided from the Raspberry Pi HAT connector
- The Control Pilot PWM signal is generated and selected by Raspberry Pi
- Constant-power mode is used

5.2 IEC 61851-1 source: DB2605

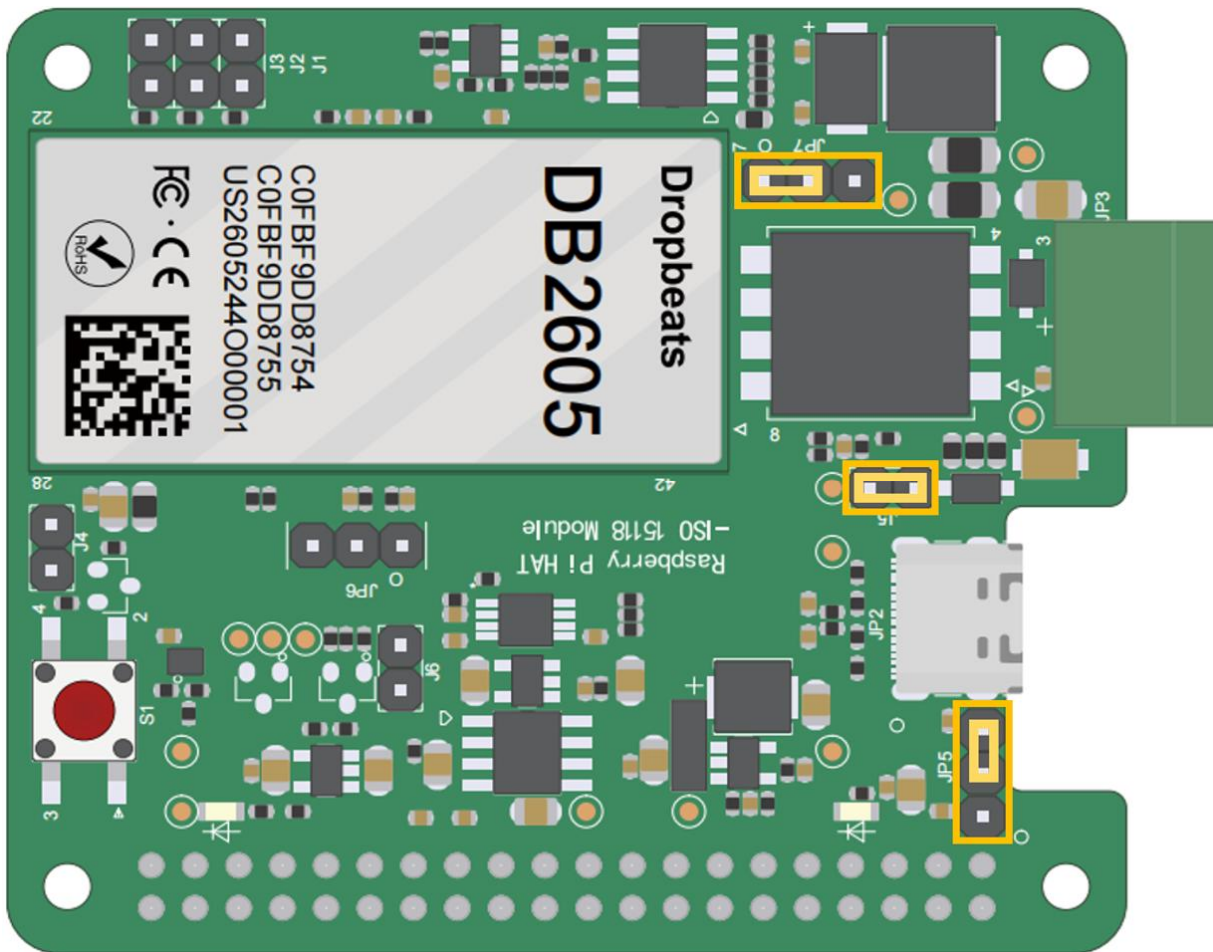

Figure 4 – IEC 61851-1 source: DB2605

In this example,

- Power is provided from the USB type C connection
- The Control Pilot PWM signal is generated and selected by the DB2605
- Low-power mode is enabled (J6 jumper not installed)
- Proximity power is supplied to support Europe charge mode 3

6 Safety

To ensure safe use and avoid injury or property damage, follow these safety instructions.

- Avoid stress and vibration on all mechanical assemblies
- In case of malfunction, stop use and seek professional repair
- Turn off all power before making any changes to the configuration

Legal Information

Copyright

Copyright 2024 Dropbeats Technology Co.,Ltd. All rights reserved.

The information in this document is proprietary and confidential to Dropbeats Technology Co., Ltd., and for its customers' internal use. No part of this document may be reproduced or redistributed in any form without the express written consent of Dropbeats Technology Co., Ltd.

Disclaimer

None of the information contained in this document constitutes an express or implied warranty by Dropbeats Technology Co., Ltd. as to the sufficiency, fitness or suitability for a particular purpose of any such information or the fitness, or suitability for a particular purpose, merchantability, performance, compatibility with other parts or systems, of any of the products of Dropbeats Technology Co., Ltd., or any portion thereof, referred to in this document. Dropbeats Technology Co., Ltd. expressly disclaims all representations and warranties of any kind regarding the contents or use of the information, including, but not limited to, express and implied warranties of accuracy, completeness, merchantability, fitness for a particular use, or non-infringement.

In no event will Dropbeats Technology Co., Ltd. be liable for any direct, indirect, special, incidental or consequential damages, including, but not limited to, lost profits, lost business or lost data resulting from any use of or reliance upon the information, whether or not Dropbeats Technology Co., Ltd. has been advised of the possibility of such damage.

Intellectual Property

The technology discussed in this document is protected by one or more US, Canadian, or other international patent grants.

For a complete list of Dropbeats' trademarks and registered trademarks, visit: <https://www.dropbeats.com/>

Contacting Dropbeats Technology

Dropbeats Technology
123 Juli Road, Building 4, Shanghai, China
Tel: +86 (21) 5085-0752
Fax: +86 (21) 5085-0753
Document Information: document@drop-beats.com
Corporate Information: info@drop-beats.com
Technical Support: apps@drop-beats.com
Web Site: <https://www.drop-beats.com>

Revision History

Revision	Date	Description
1.0.0	2024.4.24	Initial
1.0.1	2024.6.24	Updated related documents
1.0.2	2024.7.18	Added SD Cards and Protective acrylic shield in.
1.0.3	2024.7.19	Revised IEC 61851-1 Source CCU examples.