

# Features

- Unique, patent-pending design
- Isolated power supply with integrated mains filter
- Packaged inside of line filter case
- Safe, touchable DC outputs
- Easy installation
- Worldwide standard IEC input
- 85-264VAC universal input voltage

# Regulated Converter



## RAC05-K/C14

5 Watt  
Single  
Output



UL/IEC/EN62368-1 certified  
IEC/EN60950-1 certified  
FCC Part 15 compliant  
ANSI C63.4 compliant  
IEC/EN61204-3 compliant  
EN55014-1 / +2 compliant  
EN55024 compliant  
EN55032 compliant  
CB Report

## Description

The RAC05-K/C14 is a unique design that combines a mains filter and isolated power supply in the same case as a mains input filter alone, at a cost lower than many mains filters. It fits into a standard IEC "kettle connector" mounting hole, so installation time is only a few seconds. The touchable output spade terminals are safe extra-low voltage (SELV) available in 3.3V, 5V, 12V, 15V and 24V DC output voltages and are protected against short circuits, overload and overvoltage. The metal case offers secure fixing and enhances thermal dissipation allowing an operating temperature from -25°C to +70°C. The RAC05-K/C14 is ideal for powering single board computers such as the Raspberry Pi (including touchscreen), Arduino, BBC Micro:bit, etc.

## Selection Guide

Part Number	Input Voltage Range [VAC]	Output Voltage [VDC]	Output Current [mA]	Efficiency typ <sup>(1)</sup> [%]	Max. Capacitive Load <sup>(2)</sup> [µF]
RAC05-3.3SK/C14	85-264	3.3	1510	76	6000
RAC05-05SK/C14	85-264	5	1000	80	6000
RAC05-12SK/C14	85-264	12	420	81	1500
RAC05-15SK/C14	85-264	15	333	81	1000
RAC05-24SK/C14	85-264	24	210	84	330

### Notes:

Note1: Efficiency is tested at nominal input and full load at +25°C ambient  
Note2: Max Cap Load is tested at nominal input and full resistive load

## Model Numbering



### CODICO GmbH

Zwingenstraße 6-8, 2380 Perchtoldsdorf, Austria  
Telefon: +43 1 86 305-0, Fax: +43 1 86 305-5000  
e-mail: office@codico.com, www.codico.com  
FN 436940i, Landesgericht Wr. Neustadt

Zertifiziert nach ISO 9001:2015

**Specifications** (measured @ Ta= 25°C, nom. Vin, full load and after warm-up unless otherwise stated)

### BASIC CHARACTERISTICS

Parameter	Condition		Min.	Typ.	Max.
Internal Input Filter			Pi type		
Input Voltage Range <sup>(3,4)</sup>	nom. Vin= 230VAC		85VAC 120VDC	230VAC	264VAC 370VDC
Input Current	115VAC 230VAC				250mA 100mA
Inrush Current	cold start at 25°C	115VAC 230VAC			15A 30A
No Load Power Consumption				75mW	
ErP Standby Mode Conformity (Output Load Capability)	Input Power=	0.5W 1.0W 2.0W			0.3W 0.7W 1.5W
Input Frequency Range	AC Input		47Hz		63Hz
Minimum Load			0%		
Power Factor	115VAC 230VAC		0.6 0.45		
Start-up Time				20ms	
Rise Time					8ms
Hold-up Time	115VAC 230VAC			12ms 60ms	
Internal Operating Frequency					130kHz
Output Ripple and Noise	20MHz BW	3.3Vout, 5Vout others		60mVp-p	1% of Vout

**Notes:**

Note3: The products were submitted for safety files at AC-Input operation

Note4: Refer to "Line Derating"

### Efficiency vs. Load

RAC05-3.3SK/C14

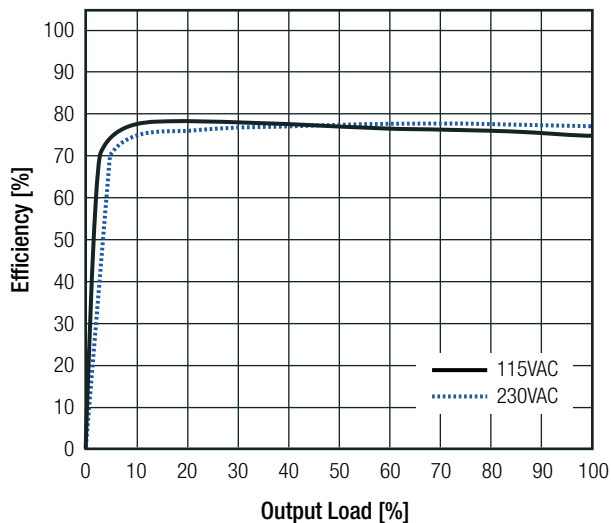

RAC05-05SK/C14

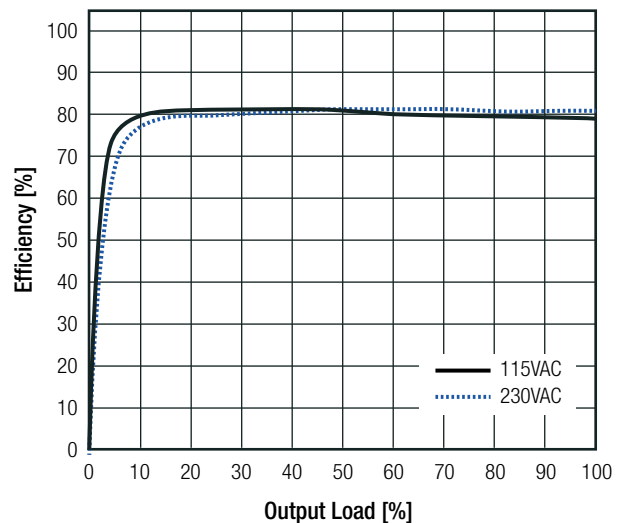

continued on next page

**Specifications** (measured @ Ta= 25°C, nom. Vin, full load and after warm-up unless otherwise stated)

### Efficiency vs. Load

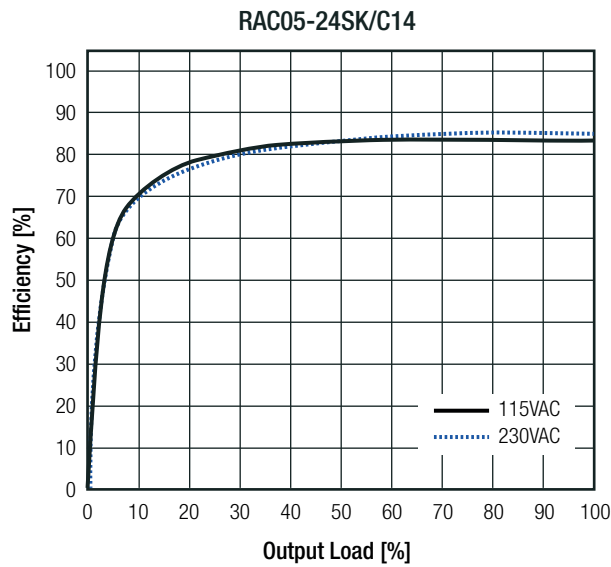
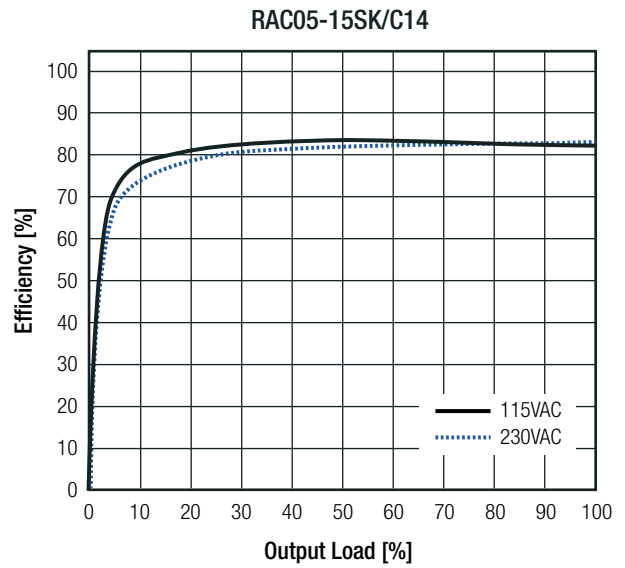
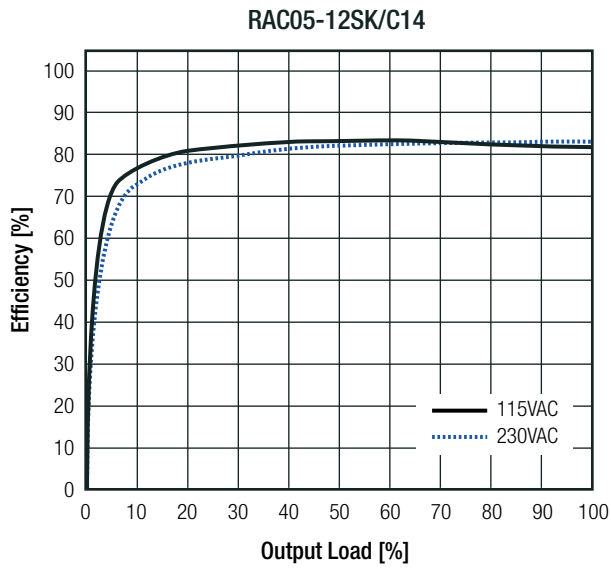

### REGULATIONS

Parameter	Condition	Value
Output Accuracy		±2.0% typ.
Line Regulation	low line to high line, full load	±0.5% typ.
Load Regulation	10% to 100% load	±1.0% typ.
Transient Response	25% load step change recovery time	4.0% max. 500µs typ.

### Specifications (measured @ Ta= 25°C, nom. Vin, full load and after warm-up unless otherwise stated)

#### PROTECTIONS

Parameter	Type		Value
Input Fuse <sup>(5)</sup>	internal		T1A, slow blow
Short Circuit Protection (SCP)	below 100mΩ		Hiccup, automatic restart
Over Voltage Protection (OVP)			125% - 195%, Latch-off
Over Voltage Category			OVCII
Over Current Protection (OCP)			125% - 195%, Hiccup auto recovery
Class of Equipment			Class I
Isolation Voltage <sup>(6)</sup>	I/P to O/P; I/P to Case (GND)	rated for 1 minute	3kVAC
Isolation Resistance			1GΩ min.
Isolation Capacitance			100pF max.
Insulation Grade			reinforced
Leakage Current			0.25mA max.

#### Notes:

Note5: Refer to local safety regulations if input over-current protection is also required

Note6: For repeat Hi-Pot testing, reduce the time and/or the test voltage

#### ENVIRONMENTAL

Parameter	Condition		Value
Operating Temperature Range	@ natural convection 0.1m/s	full load	-25°C to +60°C
		refer to derating graph	-25°C to +70°C
Maximum Case Temperature			+90°C
Temperature Coefficient			±0.05%/K
Operating Altitude			3000m
Operating Humidity	non-condensing		5% - 95% RH max.
Pollution Degree			PD2
Vibration	10-500Hz, 2G 10min./ 1 cycle, period o 60min. each along X,Y and Z axes		
MTBF	according to MIL-HDBK-217F, G.B.	+25°C	450 x 10 <sup>3</sup> hours
		+50°C	250 x 10 <sup>3</sup> hours
Design Lifetime			136 x 10 <sup>3</sup> hours

#### Derating Graph

(@ Chamber and natural convection 0.1m/s)

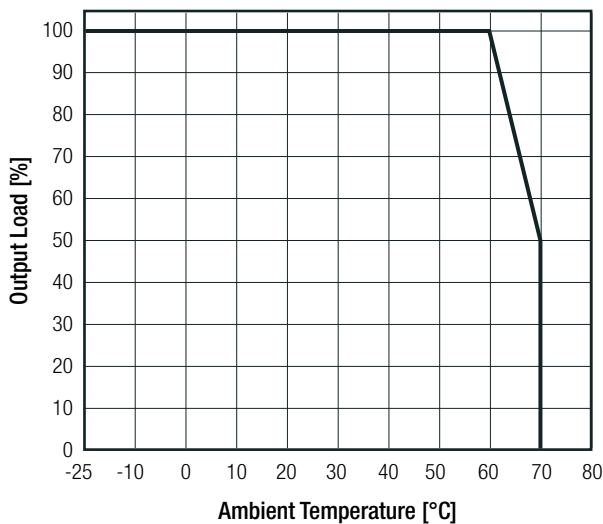

#### Line Derating

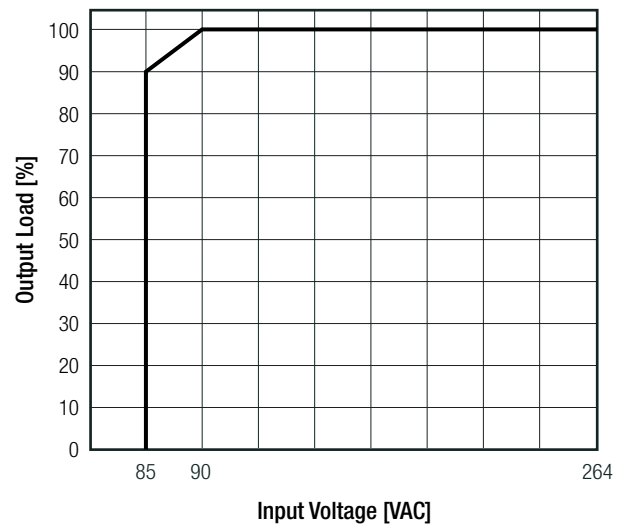

**Specifications** (measured @ Ta= 25°C, nom. Vin, full load and after warm-up unless otherwise stated)

SAFETY AND CERTIFICATIONS		
Certificate Type (Safety)	Report / File Number	Standard
Audio/video, information and communication technology equipment - Safety requirements (CB)	ITAV-4788488757-A-2	IEC62368-1:2014 2nd Edition
Audio/video, information and communication technology equipment - Safety requirements (LVD)		EN62368-1:2014 + A11:2017
Audio/video, information and communication technology equipment - Safety requirements	E224736	UL62368-1, 2nd Edition, 2014 CAN/CSA-C22.2 No. 62368-1-14, 2nd Ed.
Information Technology Equipment, General Requirements for Safety (CB)		IEC60950-1:2005 + A2:2013, 2nd Edition
Information Technology Equipment, General Requirements for Safety		EN60950-1:2006 + A2:2013
RoHS2+	LCS180702077AR	RoHS 2011/65/EU + AM2015/863
EMC Compliance		
Condition	Standard / Criterion	
Low-voltage power supplies DC output - Part 3: Electromagnetic compatibility	LCS180702043BE	EN IEC61204-3:2018, Class B
Electromagnetic compatibility of multimedia equipment - Emission requirements		EN55032:2015, Class B
Information technology equipment - Immunity characteristics - Limits and methods of measurement		EN55024:2010 + A1:2015
Electromagnetic compatibility of household appliances, electric tools and similar apparatus - Emission Requirements		EN55014-1:2006 + A2:2011
Electromagnetic compatibility of household appliances, electric tools and similar apparatus - Immunity Requirements		EN55014-2:2015
American National Standard for Methods of Measurement of Radio-Noise Emissions from Low-Voltage Electrical and Electronic Equipment in the Range of 9kHz to 40GHz	LCS180702044BE	ANSI C63.4-2014, Class B
Limitations on the amount of electromagnetic interference allowed from digital and electronic devices		FCC 47 CFR Part15, Subpart B
ESD Electrostatic Discharge Immunity Test	Air: ±2, 4, 8kV Contact: ±2, 4kV	EN61000-4-2 :2009, Criteria B
Radiated, Radio-Frequency, Electromagnetic Field Immunity Test	10V/m, 80MHz-1GHz 3V/m, 1.4GHz-2GHz 1V/m, 2GHz-2.7GHz	EN61000-4-3:2006 + A1:2009, Criteria A
Fast Transient and Burst Immunity	AC Port: ±2kV DC Port: ±2kV	EN61000-4-4:2012, Criteria B
Surge Immunity	AC Port (L-N): ±1kV DC Port: ±0.5kV	EN61000-4-5:2014+A1:2017, Criteria B
Immunity to Conducted Disturbances, Induced by Radio-Frequency Fields	AC+DC Port: 10V	EN61000-4-6:2014, Criteria A
Power Magnetic Field Immunity	50Hz, 30A/m	EN61000-4-8:2010, Criteria A
Voltage Dips and Interruptions	Voltage Dips 20% Voltage Dips 30% Voltage Dips 60% Voltage Dips 100% Interruptions > 95%	EN61000-4-11:2004+A1:2017, Criteria C EN61000-4-11:2004+A1:2017, Criteria C EN61000-4-11:2004+A1:2017, Criteria C EN61000-4-11:2004+A1:2017, Criteria B EN61000-4-11:2004+A1:2017, Criteria C
Voltage Fluctuations and Flicker in Public Low-Voltage Systems ≤16A per phase		EN61000-3-3:2013

DIMENSION AND PHYSICAL CHARACTERISTICS		
Parameter	Type	Value
Material	case inner case potting	nickel-plated steel plastic (UL94 V-0) silicone rubber (UL96 V-0)
Dimension (LxWxH)		67.0 x 48.0 x 23.0mm
Weight		56g typ.
continued on next page		

**Specifications** (measured @ Ta= 25°C, nom. Vin, full load and after warm-up unless otherwise stated)

Dimension Drawing (mm)

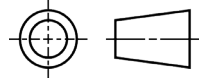
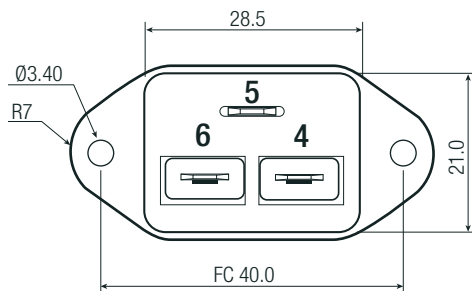
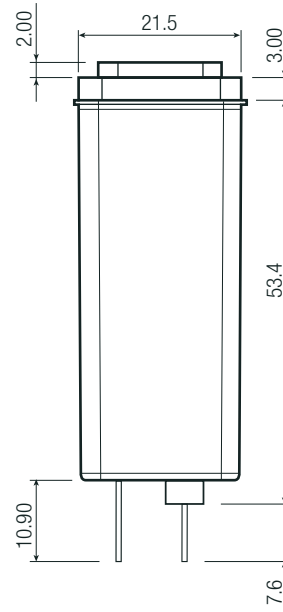
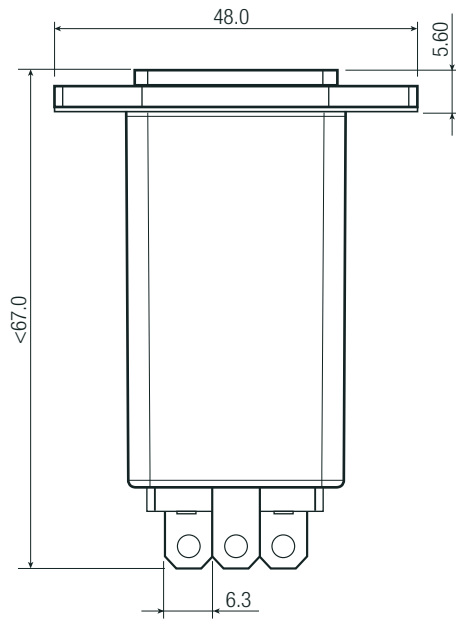
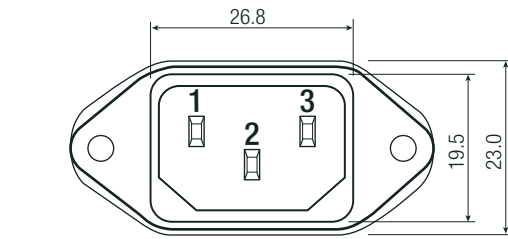

### Pinning information

Pin #	Single
1	VAC in (L)
2	Earth
3	VAC in (N)
4	+Vout
5	Earth
6	-Vout

FC= fixing centers  
Tolerance: xx.x=  $\pm 0.5$ mm  
xx.xx=  $\pm 0.25$ mm

### Mounting hole dimensions

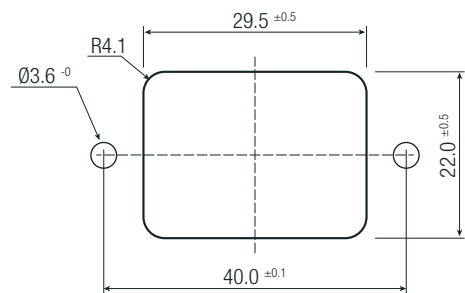

### PACKAGING INFORMATION

Parameter	Type	Value
Packaging Dimension (LxWxH)	cardboard box	166.0 x 123.0 x 91.0mm
Packaging Quantity		10pcs
Storage Temperature Range		-40°C to +85°C
Storage Humidity	non-condensing	95% RH max.

The product information and specifications may be subject to changes even without prior written notice. The product has been designed for various applications; its suitability lies in the responsibility of each customer. The products are not authorized for use in safety-critical applications without RECOM's explicit written consent. A safety-critical application is an application where a failure may reasonably be expected to endanger or cause loss of life, inflict bodily harm or damage property. The applicant shall indemnify and hold harmless RECOM, its affiliated companies and its representatives against any damage claims in connection with the unauthorized use of RECOM products in such safety-critical applications.